DAIHATSU

F300

REAR AXLE & SUSPENSION

OUTLINE OF REAR AXLE & SUSPENSION	RS- 2
REAR AXLE & SUSPENSION COMPONENTS	RS- 6
REAR SPRINGS	RS- 7
REAR SHOCK ABSORBERS	RS-17
THREE-STAGE DAMPER	RS-22
REAR AXLE SHAFT	RS-28
SSTs (special service tools)	RS-37
TIGHTENING TORQUE	RS-38

WFE90-RS001

REAR AXLE & SUSPENSION

OUTLINE OF REAR AXLE & SUSPENSION

REAR SUSPENSION

The rear suspension is a rigid type and is composed of five leaf springs. For improved negotiability over rough terrains and steering response, shackles are installed at the back side.

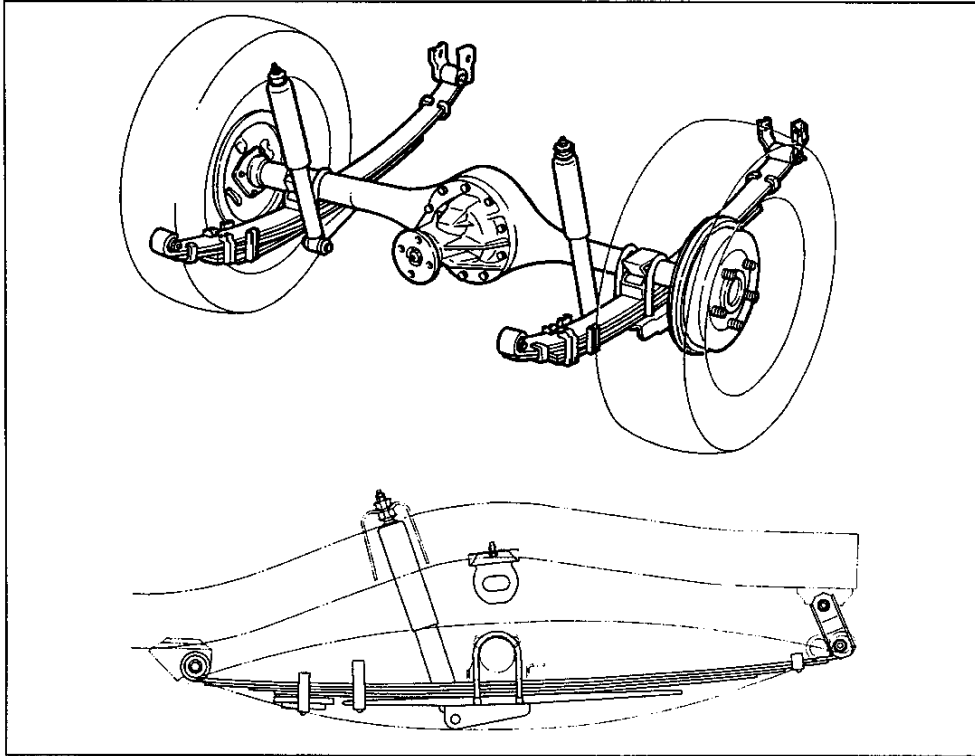

WFES0-RS002

Rear suspension specifications

Item		Vehicle model	All models (Except the United kingdom)	For the United kingdom
Leaf spring	Camber (under unloaded state)	mm	165	165
	Main spring	Span (mm) x width (mm) x sheet thickness (mm) – Number of leaves (pcs.)	1,170 x 60 x 6 – 1, 1,125 x 60 x 5 – 1 870 x 60 x 6 – 1, 965 x 60 x 5 – 1	1,170 x 60 x 7 – 1, 985 x 60 x 7 – 1 740 x 60 x 8 – 1
	Auxiliary spring	Span (mm) x width (mm) x sheet thickness (mm) – Number of leaves (pcs.)	610 x 60 x 14 – 1	430 x 60 x 12 – 1
	Spring constant	Main spring	kg/mm	1.95
Combined		kg/mm	4.61	4.61

NOTE:

- As for the shock absorber, see the Front Axle & Suspension section.

WFES0-RS003

REAR AXLE & SUSPENSION

REAR SPRINGS

The rear spring adopts leaf springs which consist of five leaves, thus assuring excellent negotiability over rough terrains.

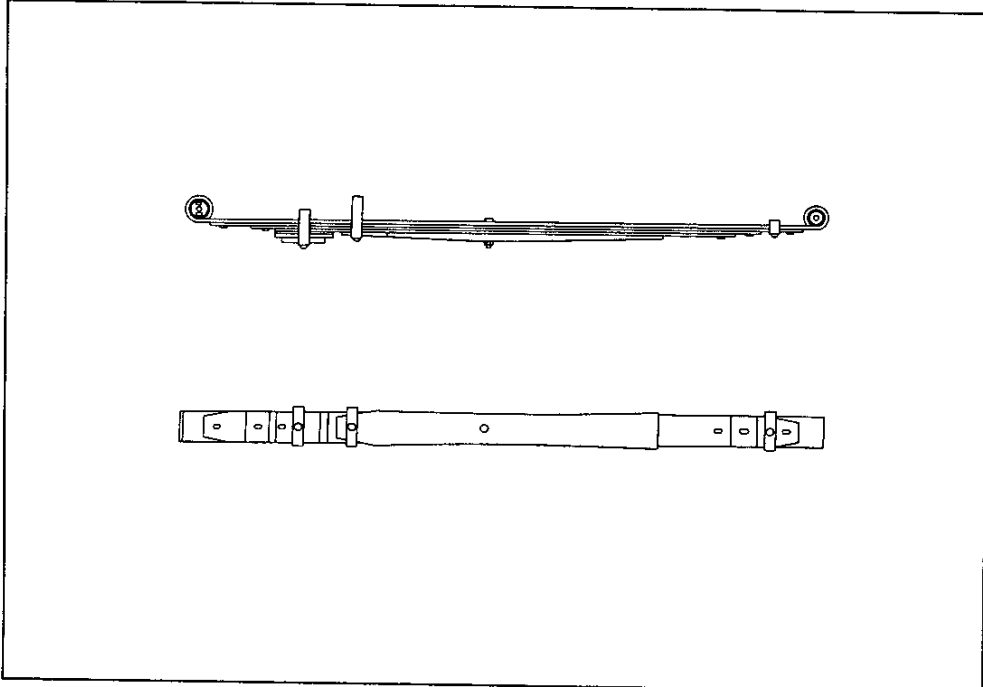

WFE30-RS004

REAR SHOCK ABSORBERS

The rear shock absorber is a nitrogen gas-sealed type shock absorber. The absorber comes in two kinds: standard type and three-stage damper type. (For details, see the section under "Front shock absorber.")

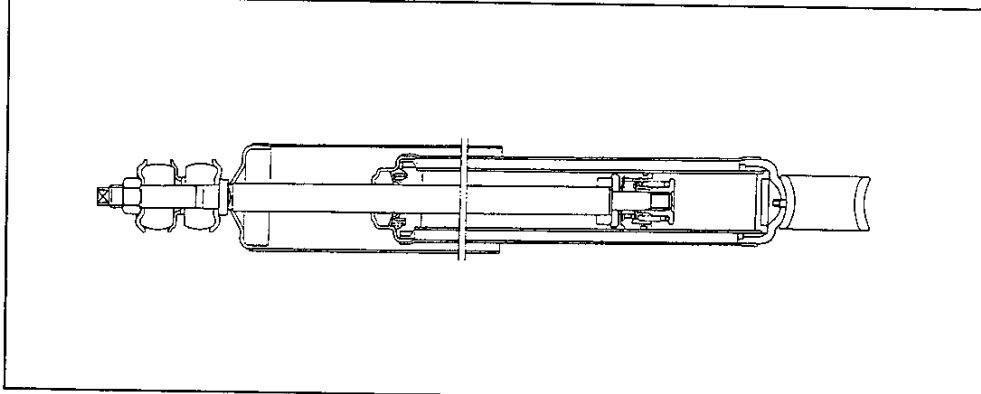

WFE30-RS005

REAR AXLE & SUSPENSION

REAR AXLE

The rear axle housing employs a banjo type, whereas the axle adopts a semi-floating type. The bearing is secured through a shrink fit. The clearance between the bearing and the backing plate is adjusted by means of adjusting shims.

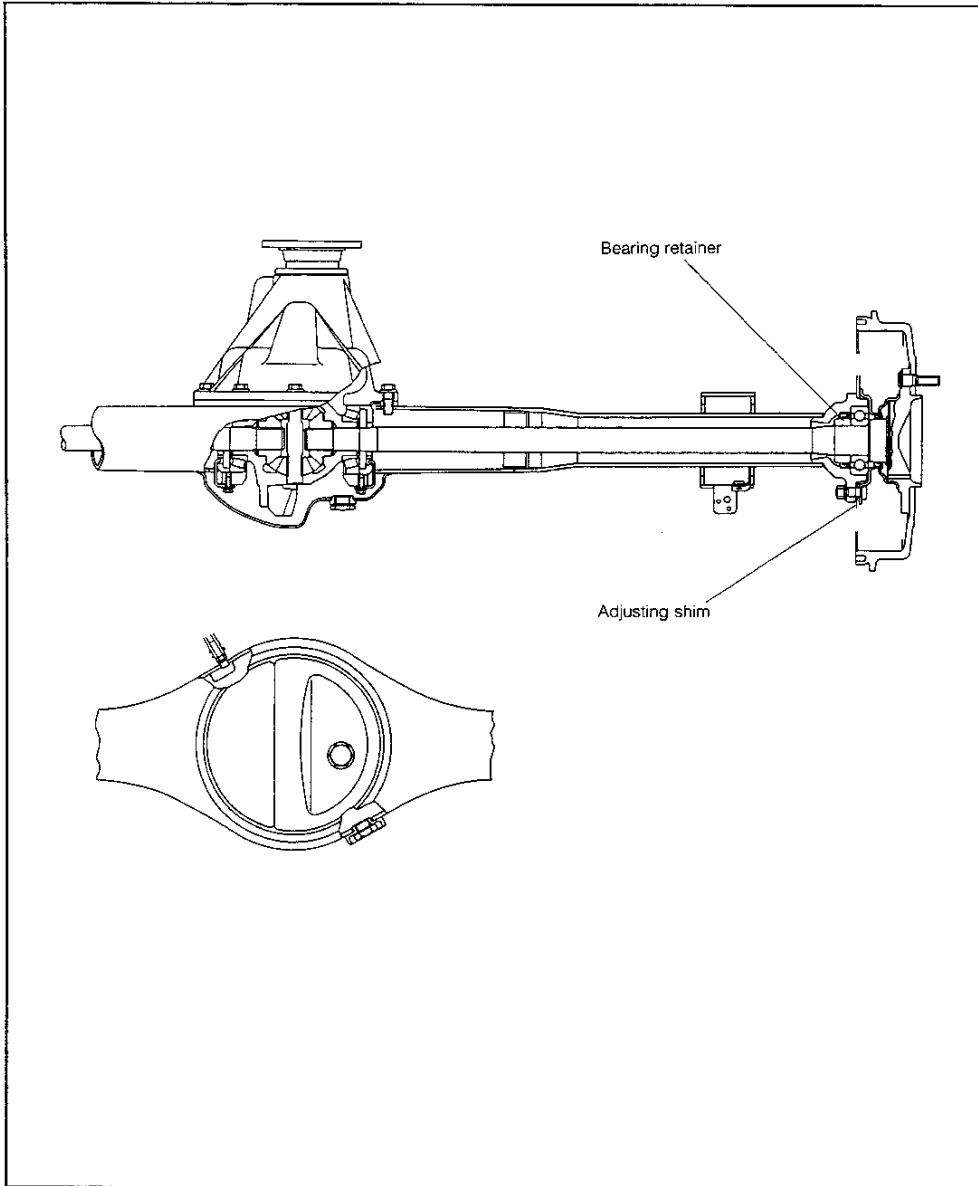

WF890-RS006

REAR AXLE & SUSPENSION

REAR AXLE SHAFTS

The rear axle shaft employs a semi-floating type, in which the wheels are directly installed to the axle shaft and the vehicle weight is divided both by the axle shaft and by the axle tube.

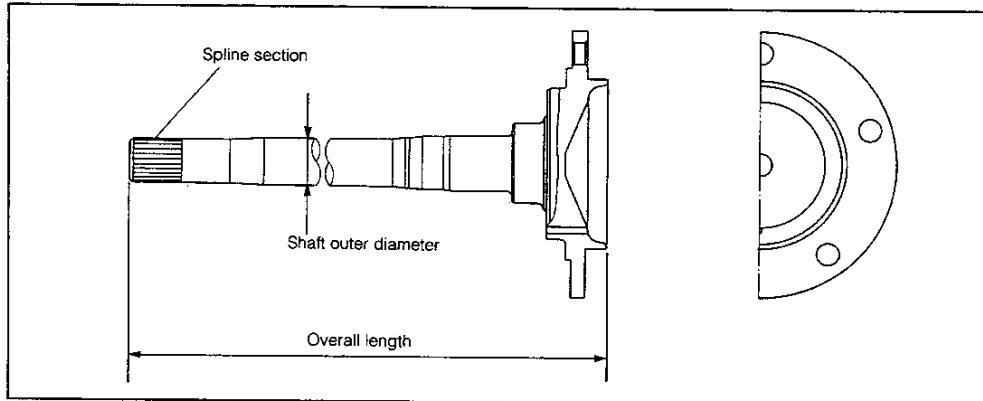

WFE90-RS007

Rear axle shaft specifications

Overall length	Right	mm	704
	Left	mm	650
Shaft outer diameter	mm		30
Number of teeth of spline section			27

WFE90-RS008

REAR AXLE HOUSING

The rear axle housing employs a banjo type rear axle housing which features remarkable strength and rigidity of the axle tube and easy removal/installation of the rear differential carrier.

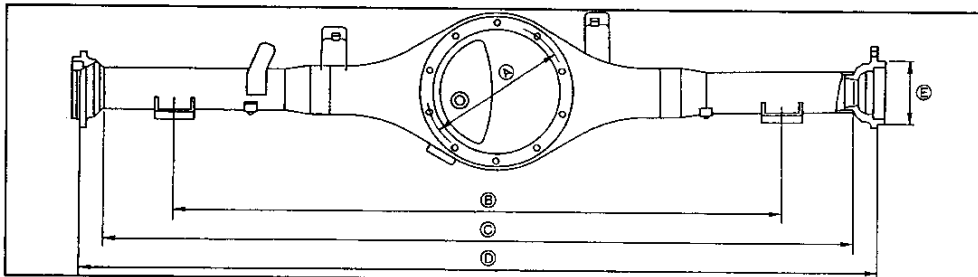

WFE90-RS009

Rear axle housing specifications

	mm
Dimension A	211
Dimension B	921
Dimension C	1157
Dimension D	1231
Dimension E	98.5

WFE90-RS010

REAR AXLE & SUSPENSION

REAR AXLE & SUSPENSION COMPONENTS

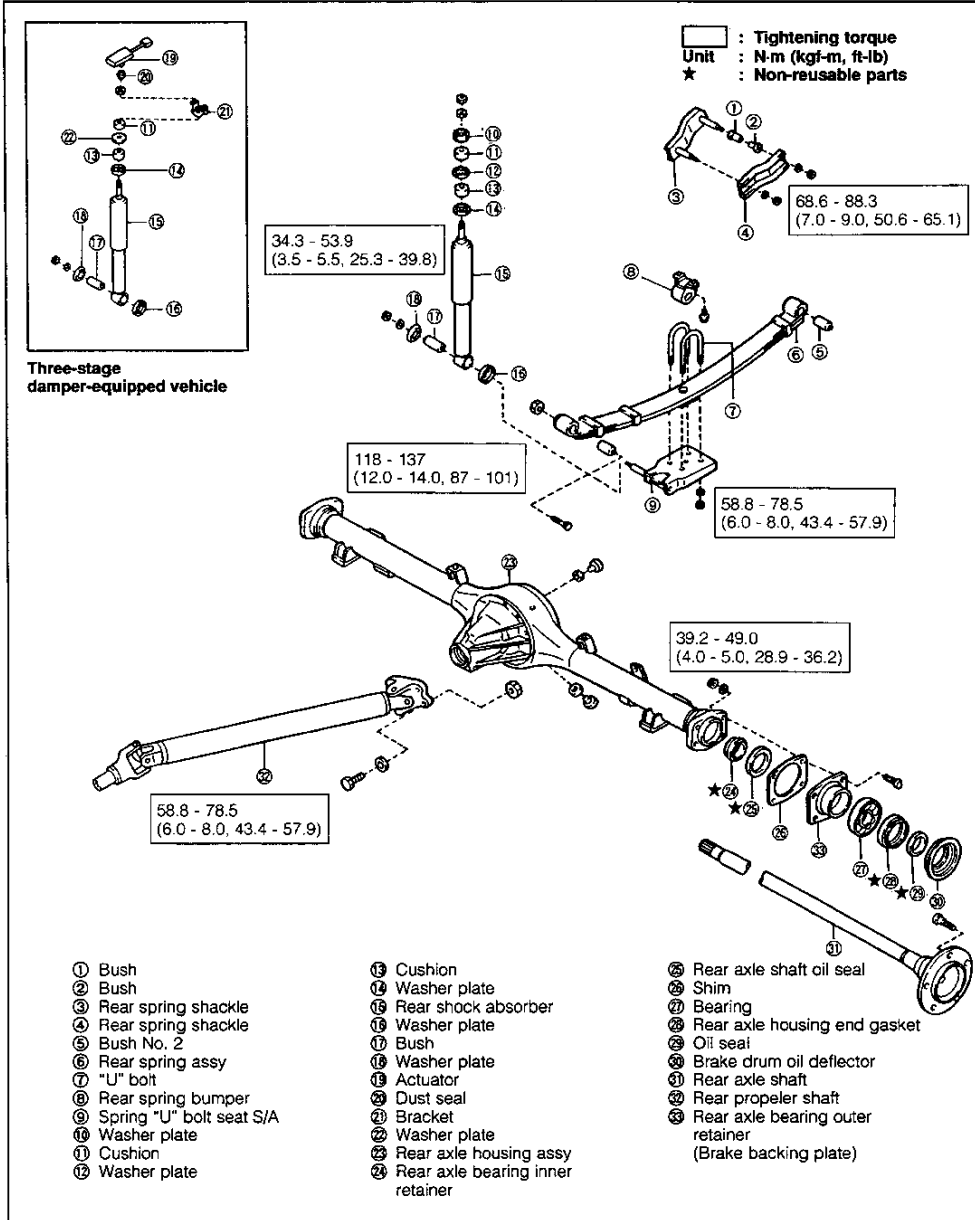

WF690-RS011

**REAR SPRINGS
COMPONENTS**

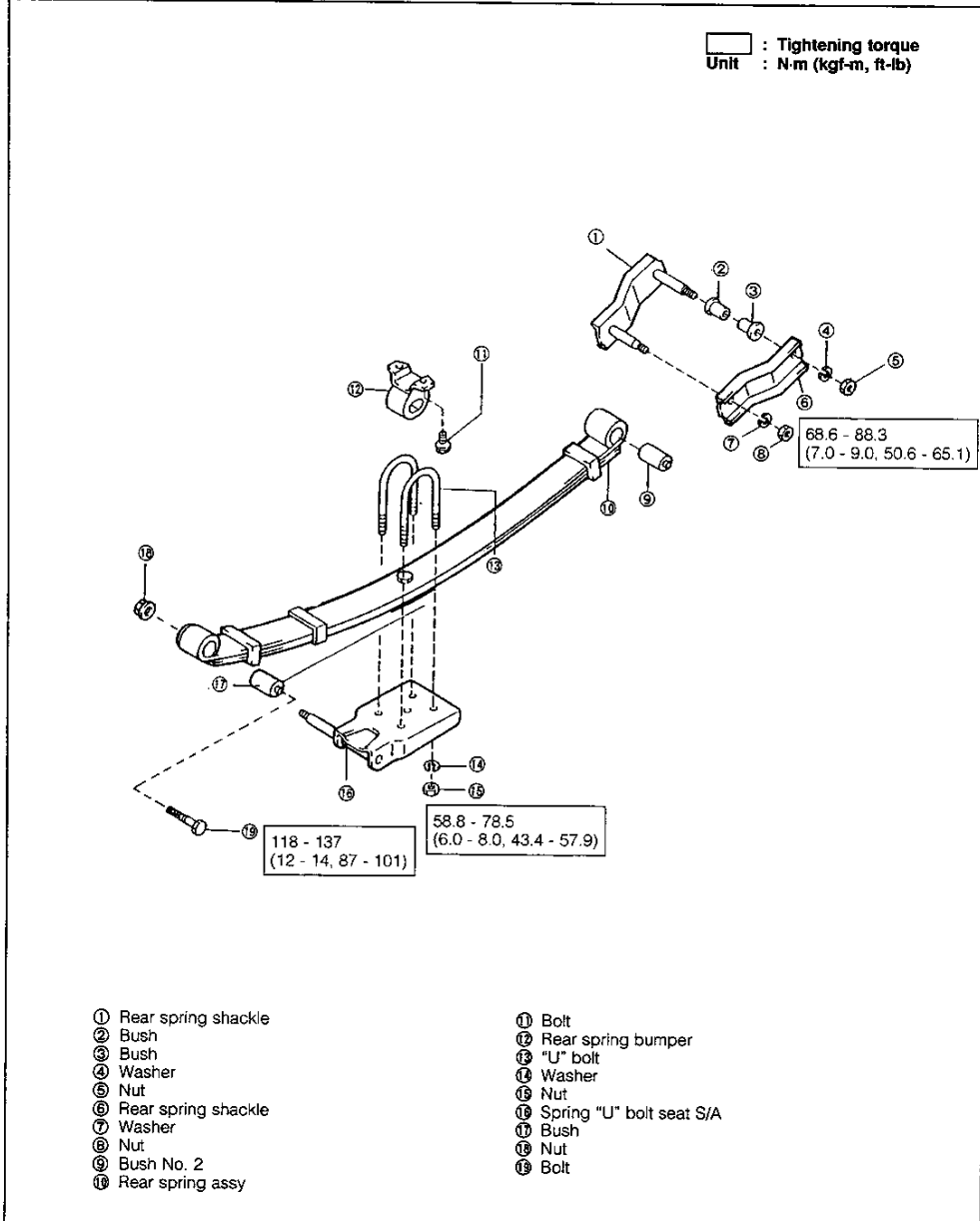

WFE90-RS012

REAR AXLE & SUSPENSION

TROUBLE SHOOTING

Symptom	Possible causes	Checking points
Abnormal noise	Spring bushes worn	Check spring and bush.
Vehicle body tilted	Spring damaged	

NOTE:

- Care must be exercised so that the right and left leaf springs may not be exchanged with each other during the removal and installation of the leaf springs.
- When replacing the leaf springs, assemble them according to the following combination of the marking codes (+, 0, -) which were put on the leaf springs. The right table indicates the priority order with the top priority attached to the (1).

	Right	Left
(1)	+	0
(2)	0	-
(3)	+	-
(4)	0	0
(5)	+	+
(6)	-	-

WFE90-RS013

REMOVAL

- Remove the rear spring bumper by removing the attaching bolts.

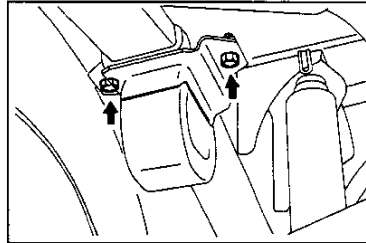

WFE90-RS014

- Remove the attaching nut at the lower side of the rear shock absorber. Disconnect the rear shock absorber from the spring "U" bolt seat subassembly.

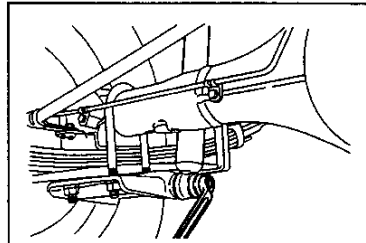

WFE90-RS015

- Remove the washer plate from the spring "U" bolt seat.

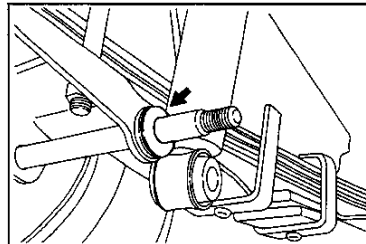

WFE90-RS016

REAR AXLE & SUSPENSION

4. Loosen the rear spring shackle attaching nut.

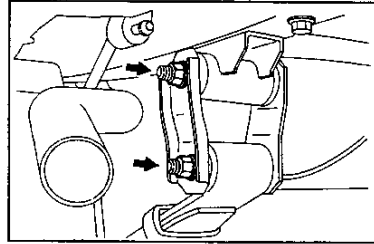

WFE90-RS017

5. Loosen the rear spring attaching nut at the front side.

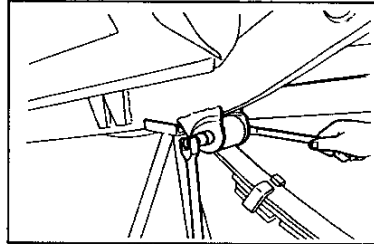

WFE90-RS018

6. Jack up the vehicle until the rear tires are just cleared from the ground (with no load applied to the rear axle). Put safety stands underneath the frame so as to support the vehicle.

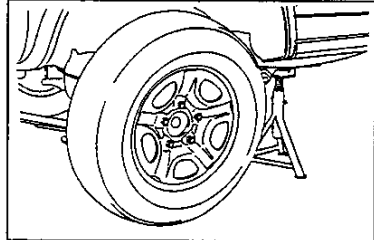

WFE90-RS019

7. Removal of "U" bolts

- (1) Measure and record the protruding dimension of the "U" bolt tightening nut.

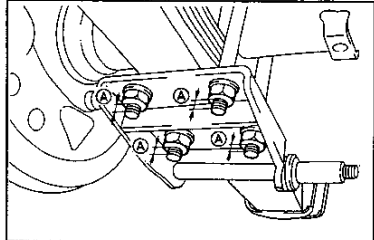

WFE90-RS020

- (2) Loosen the "U" bolt attaching nuts evenly over two or three stages.

CAUTION:

- When loosening the nuts, make sure that the spring load is not sustained by the nuts.

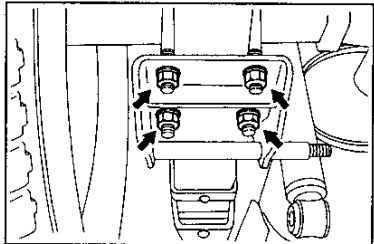

WFE90-RS021

REAR AXLE & SUSPENSION

- (3) Remove the "U" bolt attaching nuts. Remove the "U" bolt seat and "U" bolt.

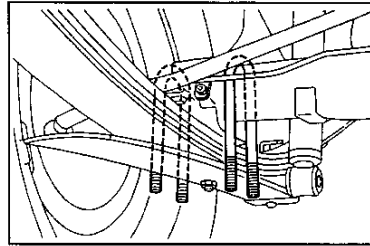

WFE90-RS022

8. Removal of rear spring shackle pin
(1) Remove the rear spring shackle attaching nuts. Remove the shackle bracket.

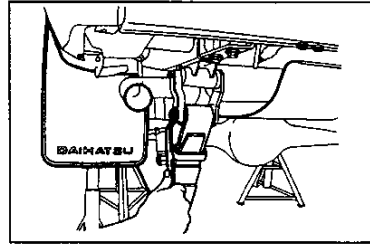

WFE90-RS023

- (2) Pull out the shackle pin about halfway by lightly tapping the shackle pin at its plate section by means of a plastic hammer or the like.

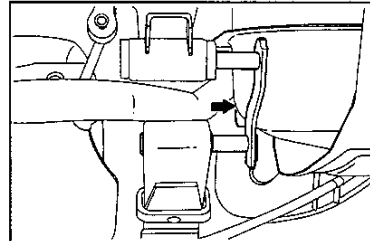

WFE90-RS024

- (3) Remove the leaf spring from the shackle pin.

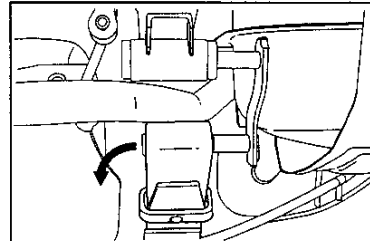

WFE90-RS025

- (4) Remove the shackle pin from the frame.

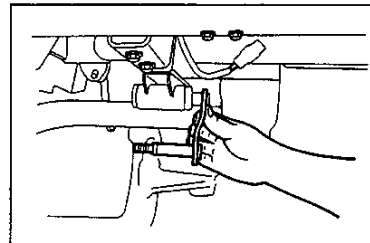

WFE90-RS026

REAR AXLE & SUSPENSION

9. Remove the shackle pin bush from the frame.

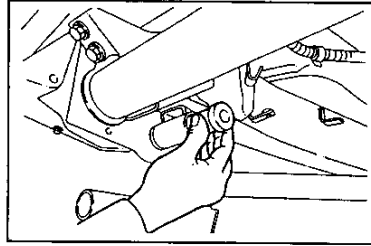

WFE90-RS027

10. Remove the leaf spring attaching bolt and nut at the front side. Remove the rear spring from the vehicle.

NOTE:

- When removing the bolt, be very careful not to drop the leaf spring.

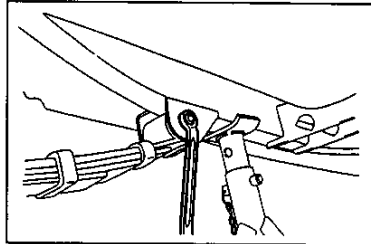

WFE90-RS028

11. Removal of rear spring bushes No.1 and No.2

- (1) Pull out the rear spring bush No.1, using the following SST in combination with a hydraulic press.
SST: 09608-87607-000

NOTE:

- Provide an adequate receiving hole at the lower side of the leaf spring so that the bush may be pulled out by a press.

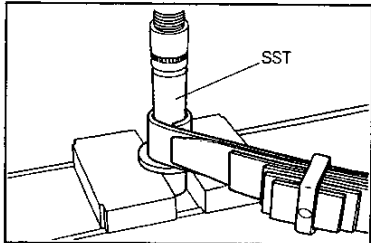

WFE90-RS029

- (2) Pull out the rear spring bush No.2, using the following SST in combination with a hydraulic press.
SST: 09608-87608-000

NOTE:

- Provide an adequate receiving hole at the lower side of the leaf spring so that the bush may be pulled out by a press.

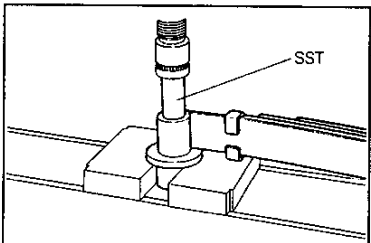

WFE90-RS030

REAR AXLE & SUSPENSION

INSPECTION

1. Inspect each section in the figure below. Replace any defective parts.

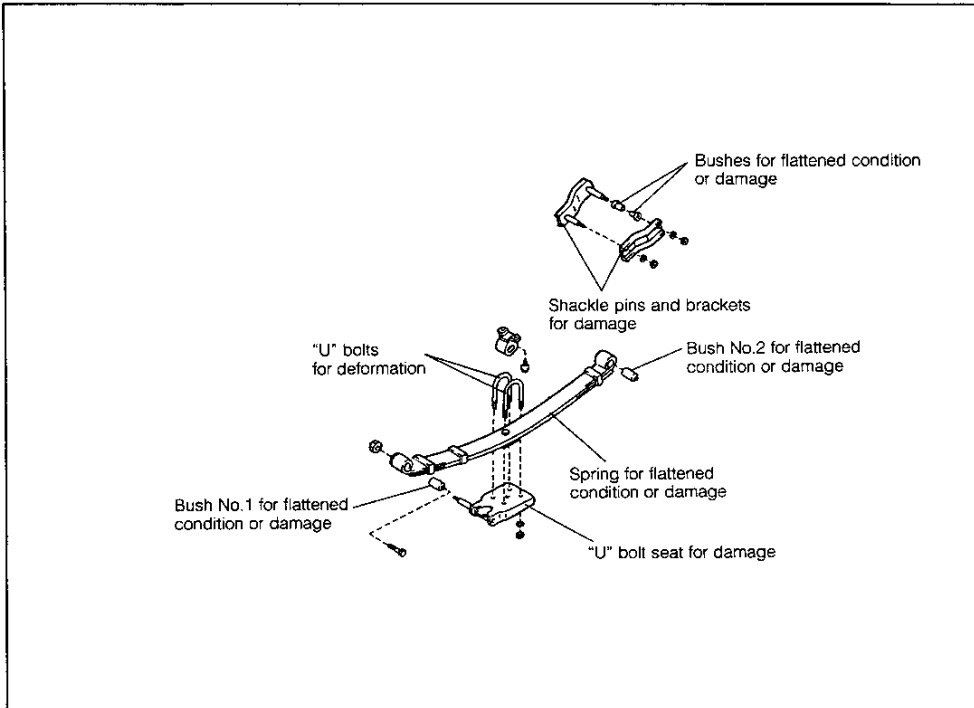

WFE90-RS031

2. Ensure that the bush installing section of the chassis exhibits no damage.

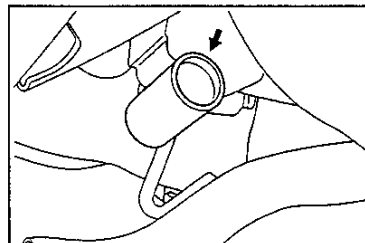

WFE90-RS032

3. Ensure that no damage is present at the leaf spring installation section at the chassis front side.

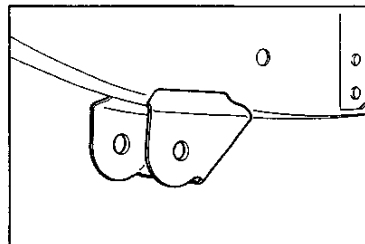

WFE90-RS033

REAR AXLE & SUSPENSION

INSTALLATION

1. Installation of rear spring bushes No.1 and No.2
 - (1) Press the rear spring bush No.1 into the rear spring with the following SST in combination with a press.
SST: 09608-87607-000

NOTE:

- Be sure to press the bush up to the edge surface of the leaf spring.
- For this operation, use a press stand having a hole so that no interference with the inner bush may occur.

- (2) Press the rear spring bush No.2 into the rear spring with the following SST in combination with a press.
SST: 09608-87608-000

NOTE:

- Be sure to press the bush up to the edge surface of the leaf spring.
- For this operation, use a press stand having a hole so that no interference with the inner bush may occur.

2. Connect the front installing section of the rear spring. Temporarily install the attaching bolt and nut.

3. Apply a thin film of SUNPAR 150[®] to the rear shackle bush. Install the bush to the frame.

4. Insert the shackle pin into the frame about halfway.

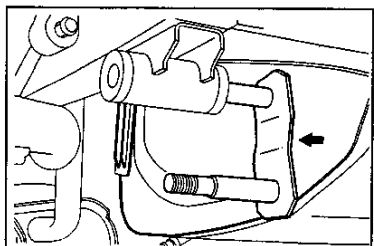
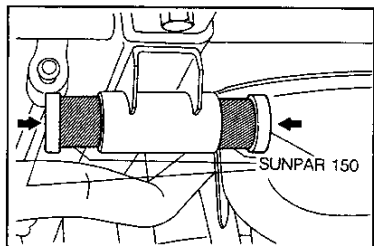
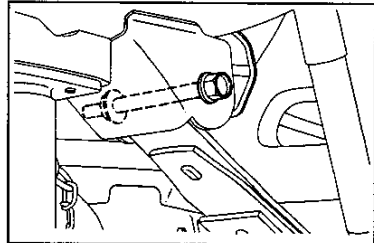
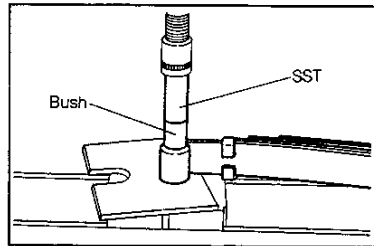
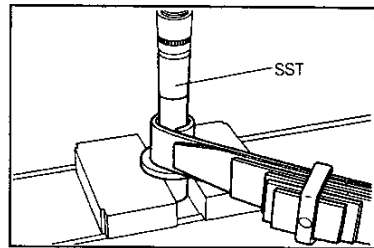

REAR AXLE & SUSPENSION

5. Connect the leaf spring to the shackle pin.

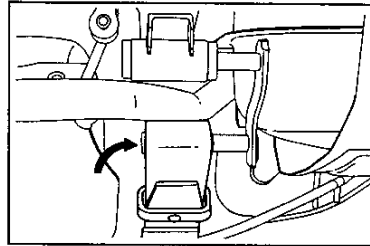

WFE90-RS039

6. Insert the shackle pin farther.

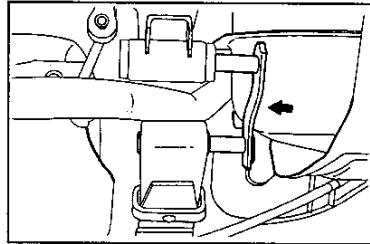

WFE90-RS040

7. Install the shackle pin bracket to the shackle pin.

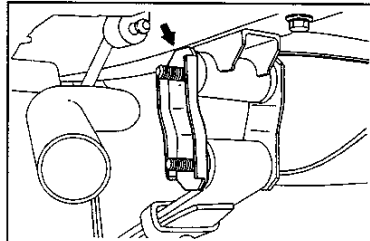

WFE90-RS041

8. Temporarily tighten the shackle pin bracket attaching nut with a new washer interposed.

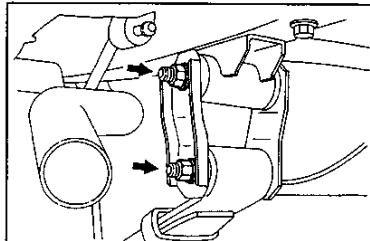

WFE90-RS042

9. Attach the bolt head of the leaf spring into the hole at the rear axle housing side.

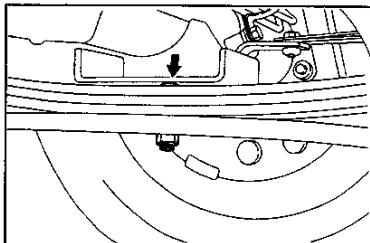

WFE90-RS043

REAR AXLE & SUSPENSION

10. Install the "U" bolts to the rear axle housing.

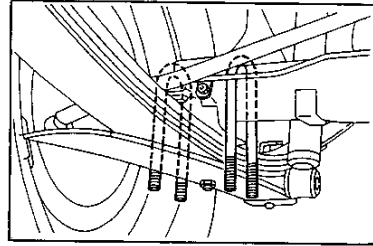

11. Install the spring "U" bolt seat. Connect the "U" bolts.
12. Tighten the spring "U" bolt seat attaching nuts with new washers interposed. This tightening must be performed evenly over two or three stages to the specified torque in such a way that all the protruding amounts (dimension A) of the four bolts may become the same.

Tightening Torque: 58.8 - 78.5 N·m
(6.0 - 8.0 kgf·m, 43.4 - 57.9 ft·lb)

NOTE:

- When the "U" bolt is reused, make sure that the protruding amounts become virtually the same as those measured during the removal.

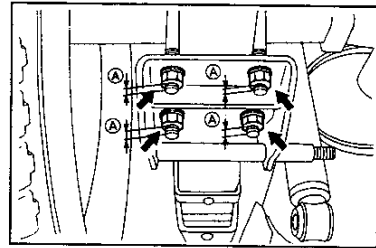

13. Jack down the vehicle.

14. Connection of shock absorber

- (1) Install the washer plate to the spring "U" bolt seat in such a way that the washer plate protruding surface may face toward the shock absorber.

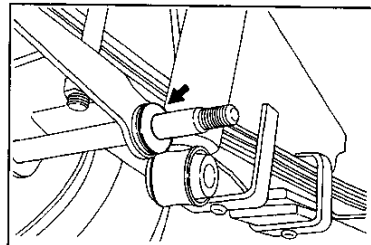

- (2) Connect the shock absorber to the spring "U" bolt seat.

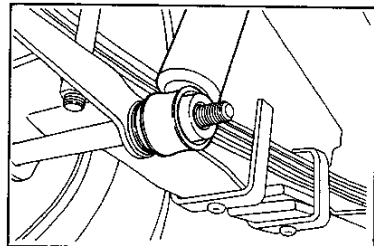

REAR AXLE & SUSPENSION

- (3) Install the washer plate to the spring "U" bolt seat in such a way that the washer plate protruding surface may face toward the shock absorber.

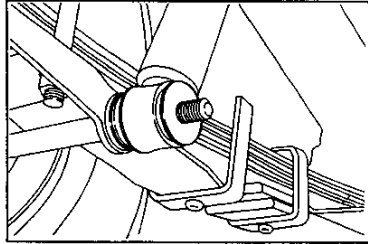

WFES0-RS049

- (4) Tighten the shock absorber attaching nut to the specified torque with a new spring washer interposed.
Tightening Torque: 34.3 - 53.9 N-m
(3.5 - 5.5 kgf-m, 25.3 - 39.8 ft-lb)

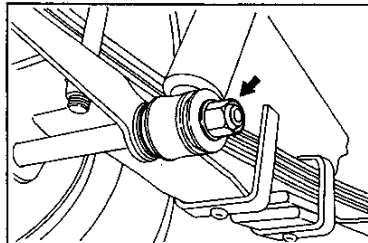

WFES0-RS050

15. Tighten the rear spring attaching bolt and nut at the front side to the specified torque.
Tightening Torque: 118 - 137 N-m
(12.0 - 14.0 kgf-m,
87.0 - 101.0 ft-lb)

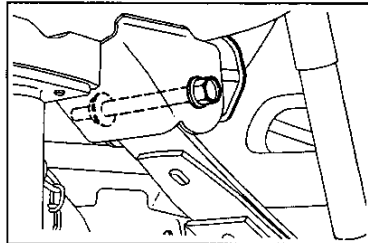

WFES0-RS051

16. Tighten the rear spring shackle attaching nuts to the specified torque.
Tightening Torque: 68.6 - 88.3 N-m
(7.0 - 9.0 kgf-m, 50.6 - 65.1 ft-lb)

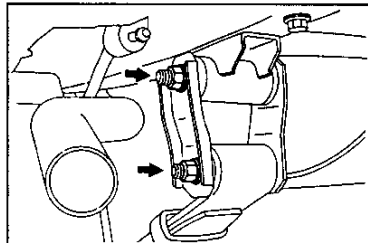

WFES0-RS052

17. Install the rear spring bumper.
Tightening Torque: 14.7 - 21.6 N-m
(1.5 - 2.2 kgf-m, 10.8 - 15.9 ft-lb)

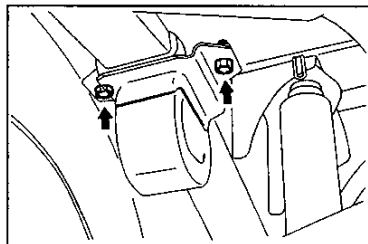

WFES0-RS053

**REAR SHOCK ABSORBERS
COMPONENTS**

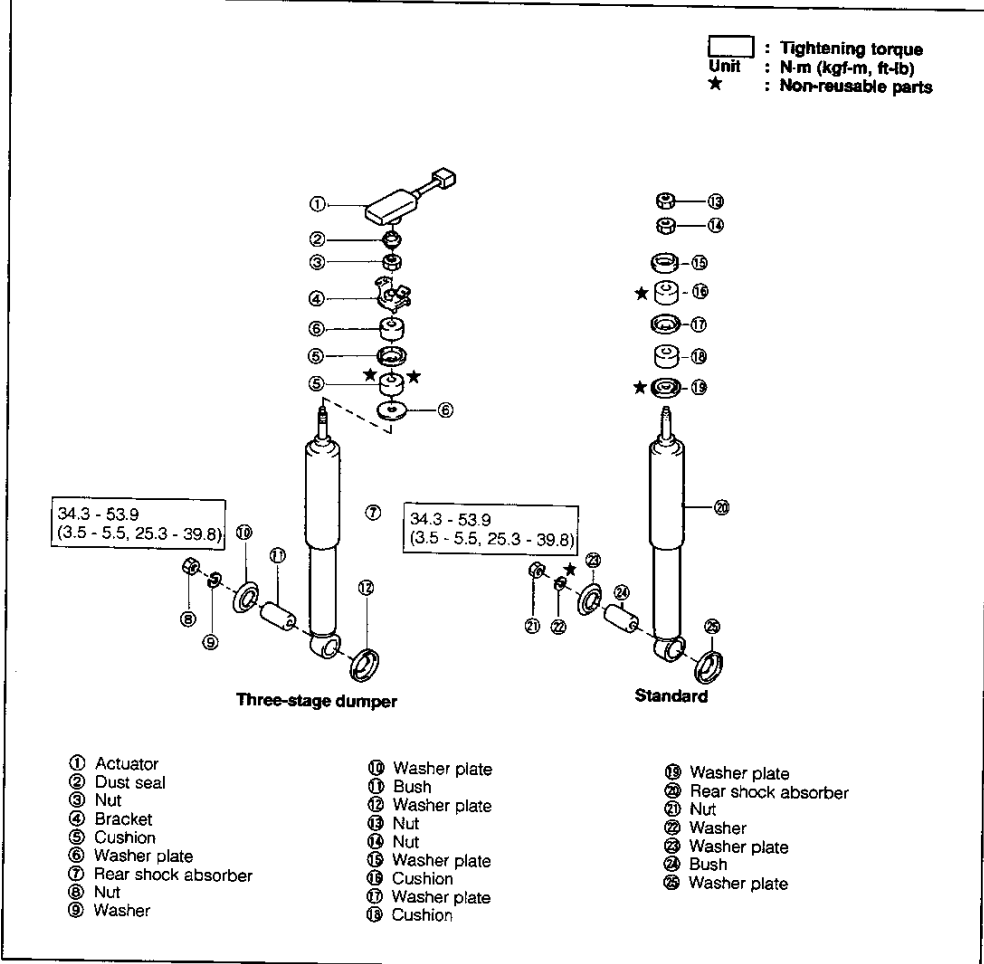

TROUBLE SHOOTING

WFE90-RS05-4

Symptom	Possible causes	Checking points
Abnormal noise	Oil leakage at shock absorber	Check shock absorber.
Oil leakage	Poor oil seal of shock absorber	

CAUTION:

- When discarding the rear shock absorber, prior to disposal be sure to release the filled gas.

WFE90-RS05-5

REAR AXLE & SUSPENSION

REMOVAL

Standard shock absorber

1. Remove the attaching nut at the spring "U" bolt seat side.

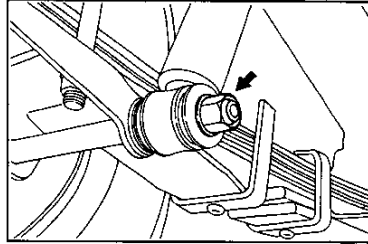

2. Remove the shock absorber from the spring "U" bolt seat.

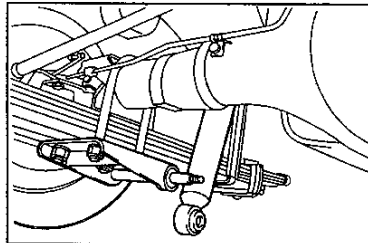

3. Jack up the vehicle and support it with safety stands.
(See GI section.)

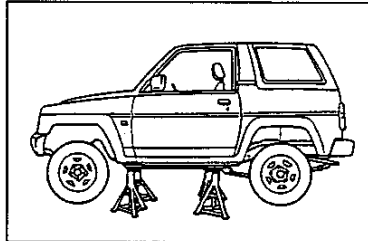

4. Loosen the lock nut provided at the upper side of the upper connecting section of the rear shock absorber.

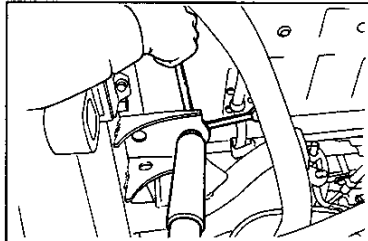

5. Remove the attaching nut while preventing the rear shock absorber from turning. For this operation, use the two-flat section provided at the top of the rear shock absorber. Remove the rear shock absorber, washer plate and cushion.

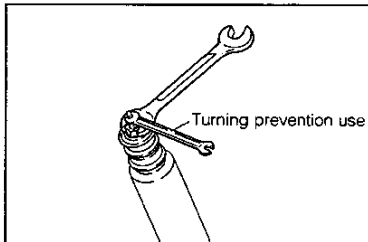

REAR AXLE & SUSPENSION

6. Remove the washer plate from the top of the rear shock absorber installation section of the frame.

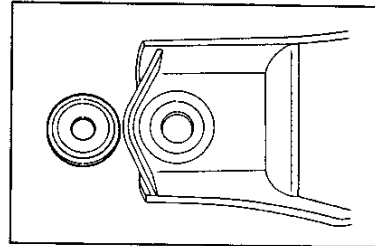

WFES0-RS061

7. Remove the cushions and washer plates from the rear shock absorber.

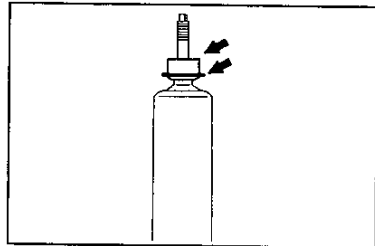

WFES0-RS062

8. Pull out the bush at the rear shock absorber lower section with a hydraulic press, while applying a suitable iron rod to the bush.

NOTE:

- This operation should be performed only when the inspection has been conducted and the removal proved to be necessary.

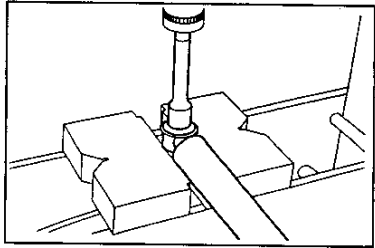

WFES0-RS063

INSPECTION

1. Inspect each section in the figure below. Replace any defective parts.

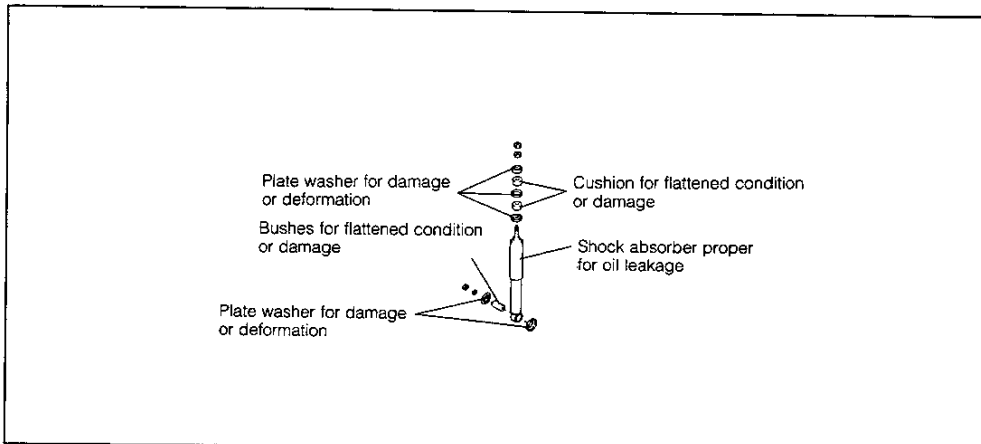

WFES0-RS064

REAR AXLE & SUSPENSION

2. Check of shock absorber

Ensure that the shock absorber can be contracted slowly when it is compressed. Also, ensure that the shock absorber can extend slowly and smoothly when it is extended.

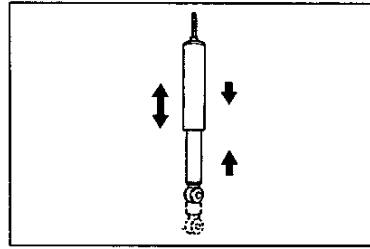

WFE90-RS065

INSTALLATION

1. Apply Sunpar 150® to the bush at the shock absorber lower section. Press the bush into the shock absorber.
2. Push the bush pressed into the shock absorber by hand to settle it.

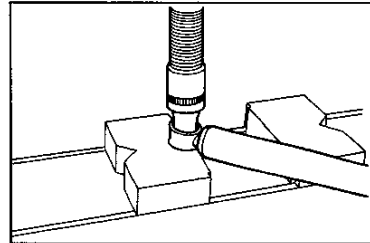

WFE90-RS066

3. Install the cushion and washer plate to the shock absorber.

NOTE:

- Be certain to install the washer so that its recessed surface faces toward the cushion side.

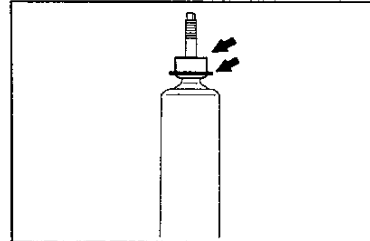

WFE90-RS067

4. Install the washer plate on the top of the shock absorber installation section of the frame.

NOTE:

- Be certain to install the washer plate in such a way that the protruding surface of the washer plate may be fitted to the hole section of the shock absorber installation section of the frame.

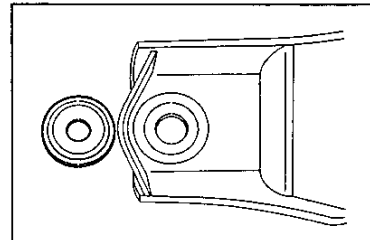

WFE90-RS068

5. Insert the rear shock absorber into the frame installation section. Install the cushion, washer plate and nut.

NOTE:

- Be certain to install the washer so that its recessed surface faces toward the cushion side.

6. Tighten the attaching nut to the specified torque, while preventing the shock absorber from turning. For this operation, use the two-flat section at the top of the rear shock absorber.

Tightening Torque: 18.6 - 30.4 N·m
(1.9 - 3.1 kgf-m, 13.7 - 22.4 ft-lb)

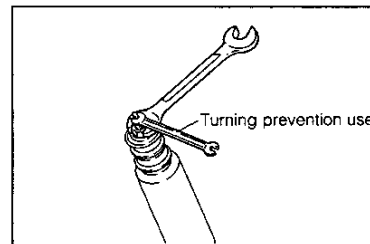

WFE90-RS069

REAR AXLE & SUSPENSION

7. Install and tighten the lock nut of the attaching nut at the upper section of the rear shock absorber.

Tightening Torque: 18.6 - 30.4 N·m
(1.9 - 3.1 kgf-m, 13.7 - 22.4 ft-lb)

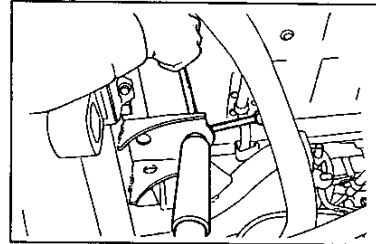

WFE90-RS070

8. Jack down the vehicle.

NOTE:

- Be very careful not to damage the shock absorber.

9. Install the washer plate to the shock absorber installation section of the spring "U" bolt seat.

NOTE:

- Be certain to install the washer plate so that the protruding side faces toward the shock absorber side.

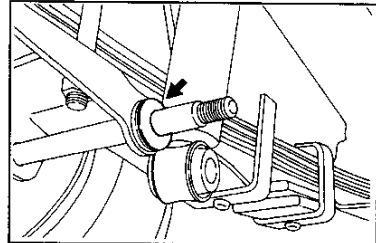

WFE90-RS071

10. Connect the shock absorber to the shock absorber installation section of the spring "U" bolt seat.

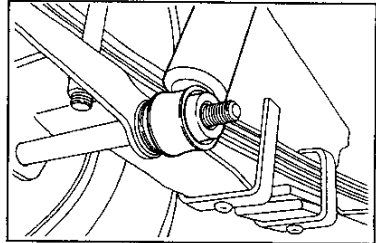

WFE90-RS072

11. Install the washer plate so that its protruding side faces toward the shock absorber side.

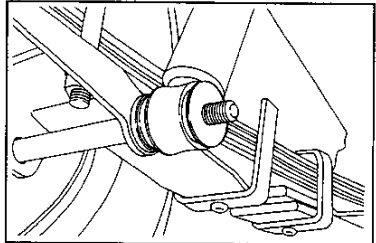

WFE90-RS073

12. Tighten the shock absorber attaching nut to the specified torque.

Tightening Torque: 34.3 - 53.9 N·m
(3.5 - 5.5 kgf-m, 25.3 - 39.8 ft-lb)

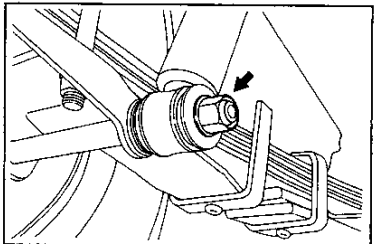

WFE90-RS074

REAR AXLE & SUSPENSION

THREE-STAGE DAMPER

REMOVAL

1. Remove the rear seat and floor mat.
(See the Body section.)
2. Remove the service hole cover by removing the attaching bolts of the service hole cover.

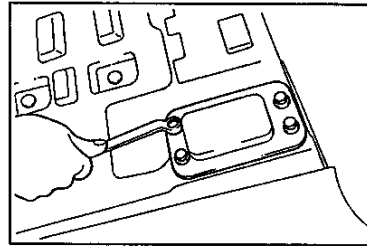

3. Pull out the three-stage actuator connector from below the floor and disconnect it.

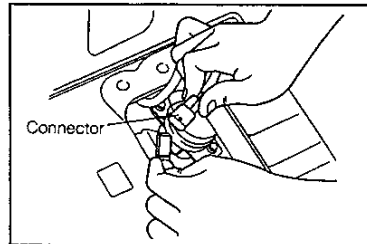

4. Remove the actuator by removing the three-stage actuator attaching screws.

NOTE:

1. When loosening the actuator bolts, while applying a standard screwdriver to the shock absorber control bracket and lightly prying the bracket, remove the bolts progressively.
Be very careful not to damage the bracket.
2. When removing the actuator, care must be exercised not to drop the collar.

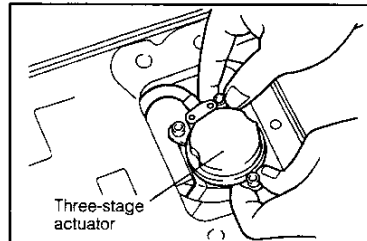
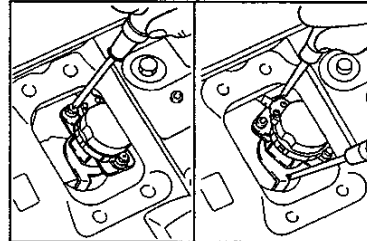

5. Remove the dust seal.

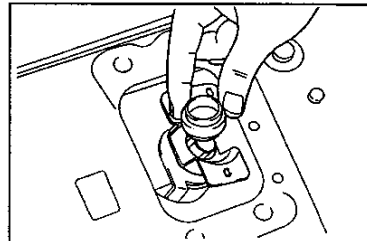

REAR AXLE & SUSPENSION

6. Remove the shock absorber control bracket by removing its attaching nuts.
7. Remove the cushion and washer plate.

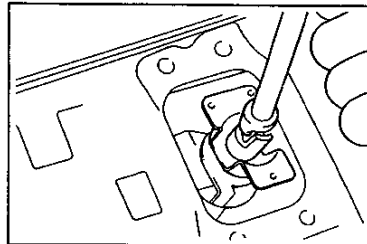

WFE90-RS079

8. Remove the attaching nut at the shock absorber lower section.

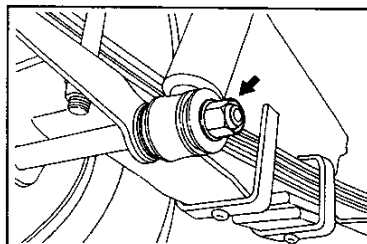

WFE90-RS080

9. Remove the shock absorber from the spring "U" bolt seat.
10. Remove the washer plate from the spring "U" bolt seat.

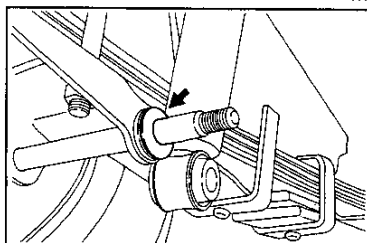

WFE90-RS081

11. Remove the cushion and washer plate from the shock absorber.

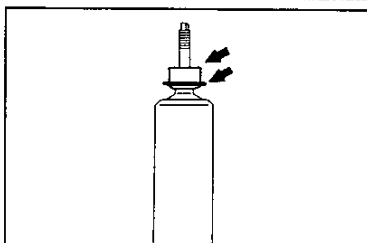

WFE90-RS082

12. Pull out the bush at the rear shock absorber lower section with a hydraulic press, while applying a suitable iron rod to the bush.

NOTE:

- This operation should be performed only when the inspection results revealed that such removal is necessary.
(See page RS-24.)

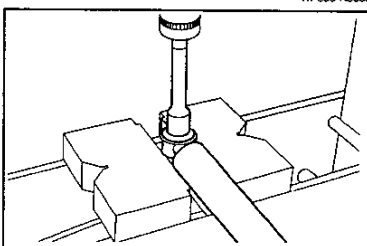

WFE90-RS083

REAR AXLE & SUSPENSION

INSPECTION

1. Inspect each section in the figure below. Replace any defective parts.

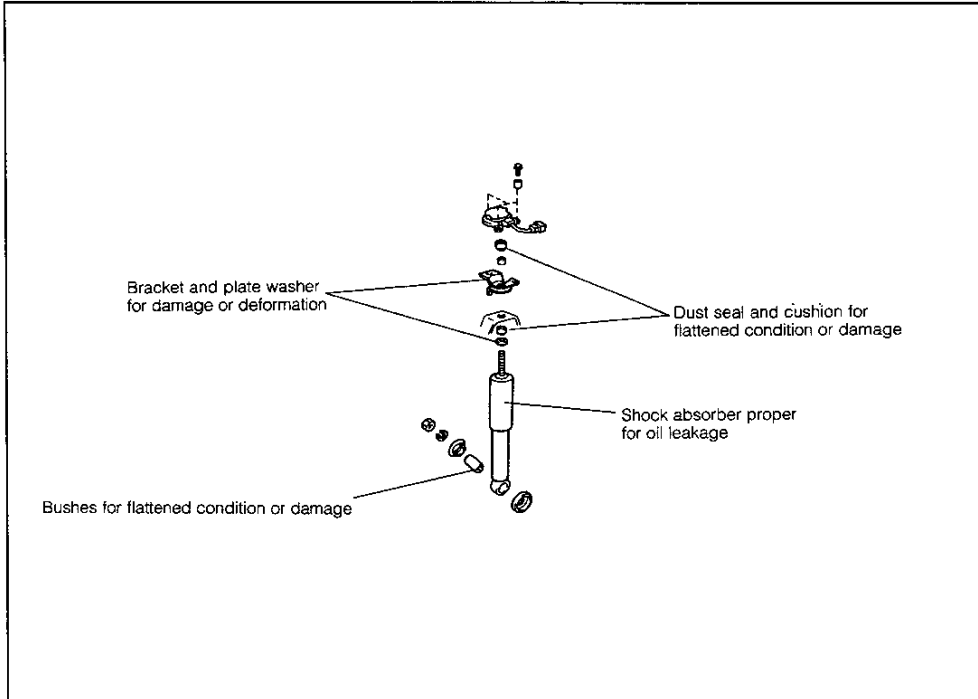

WFE90-RS084

2. Ensure that the rod at the upper side of the three-stage damper can be turned easily by radio pliers or the like.
3. Set the rod as indicated in the figure. Ensure that the damping force varies according to the modes.

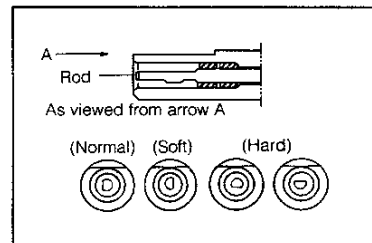

WFE90-RS085

REFERENCE:

Selection mode			Soft	Normal	Hard
Damping force (at time of piston m/s speed of 0.3 m/s)	Rebound/compression	Front	290/40	320/48	360/60
		Rear	153/13	205/21	222/25

WFE90-RS086

REAR AXLE & SUSPENSION

INSTALLATION

1. Apply Sunpar 150[®] to the bush at the shock absorber lower section. Press the bush into the shock absorber.
2. Push the bush pressed into the shock absorber by hand to settle it.

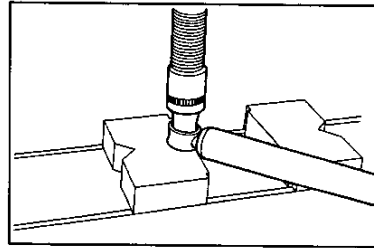

3. Install the cushion and washer plate to the shock absorber.
NOTE:
 - Be certain to install the washer so that its recessed surface faces toward the cushion side.

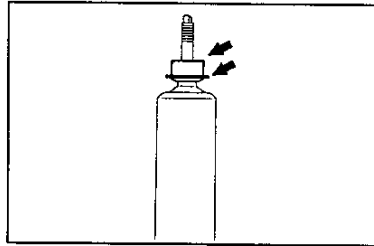

4. Install the washer plate on the top of the shock absorber installation section of the frame.

- NOTE:**
- Be certain to install the washer plate in such a way that the protruding surface of the washer plate may be fitted to the hole section of the shock absorber installation section of the frame.

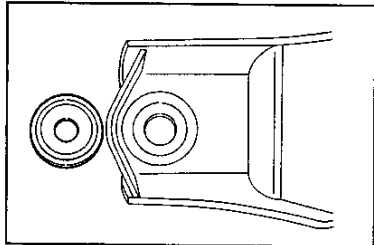

5. Insert the washer plate into the shock absorber installation section of the spring "U" bolt seat.

- NOTE:**
- Be certain to install the washer plate so that its protruding surface faces toward the shock absorber side.

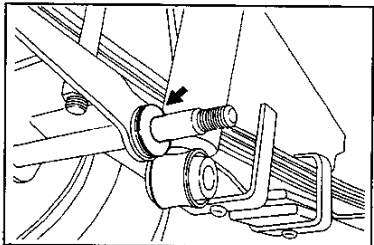

6. While inserting the shock absorber into the upper installation hole, contract the shock absorber and install it to the installation section of the spring "U" bolt seat.

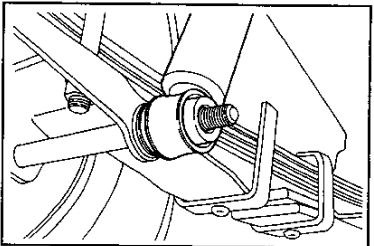

REAR AXLE & SUSPENSION

7. Install the washer plate.

NOTE:

- Be certain to install the washer so that its protruding side faces toward the shock absorber side.

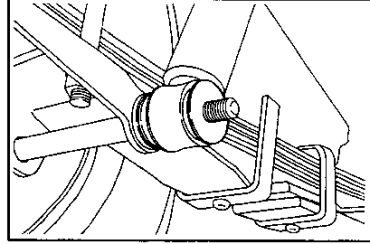

WFE90-RS092

8. Install the attaching nut at the shock absorber lower section with a new spring washer interposed. Tighten the attaching nut to the specified torque.

Tightening Torque: 34.3 - 53.9 N-m
(3.5 - 5.5 kgf-m, 25.3 - 39.8 ft-lb)

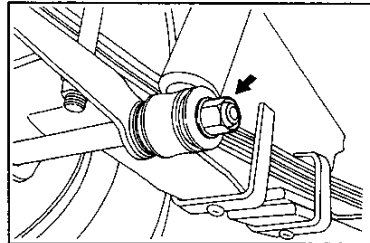

WFE90-RS093

9. Install the cushion to the top of the shock absorber.
10. Install the shock absorber control bracket in such a way that it is aligned with the cut-out section of the shock absorber upper end.

NOTE:

- Be sure to install the bracket in the correct direction.

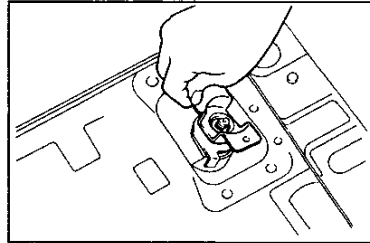

WFE90-RS094

11. Install a new nut to the shock absorber top section and tighten it to the specified torque.

Tightening Torque: 25.5 - 38.2 N-m
(2.6 - 3.9 kgf-m, 18.8 - 28.2 ft-lb)

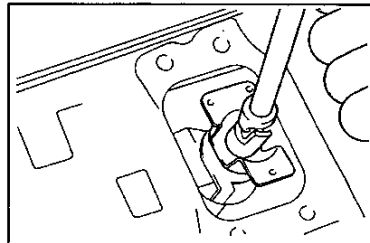

WFE90-RS095

12. Install the dust seat to the shock absorber top section.

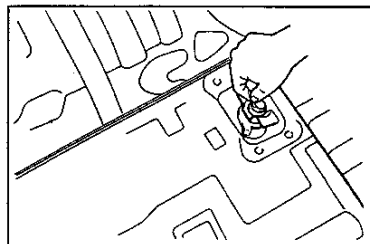

WFE90-RS096

REAR AXLE & SUSPENSION

13. Align the direction of the control shaft of the shock absorber with that of the actuator side.

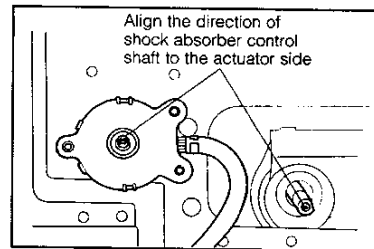

14. Install the actuator to the bracket. Tighten the attaching bolt to the specified torque.

Tightening Torque: 2.0 - 3.9 N·m
(0.2 - 0.4 kgf·m, 1.4 - 2.9 ft·lb)

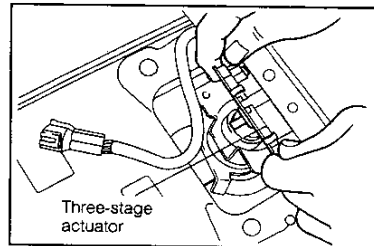

NOTE:

1. When installing the actuator, care must be exercised not to drop the collar.
2. When tightening the attaching bolts of the actuator, tighten the bolts progressively by turning the bracket. Be very careful not to damage the bracket.

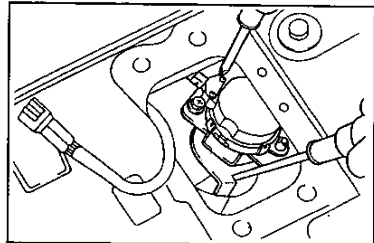

15. Connect the connector of the three-stage actuator and route it under the floor. Secure it with clamps.

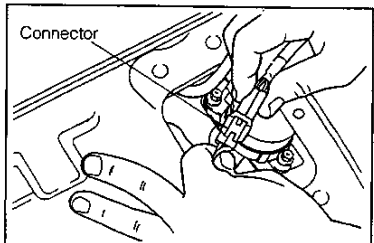

16. Install the service hole cover. Tighten the attaching bolts.
17. Install the rear seat and floor mat.
(See the Body section.)

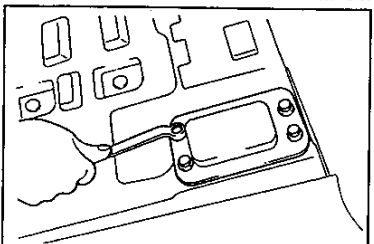

REAR AXLE & SUSPENSION

REAR AXLE SHAFT COMPONENTS

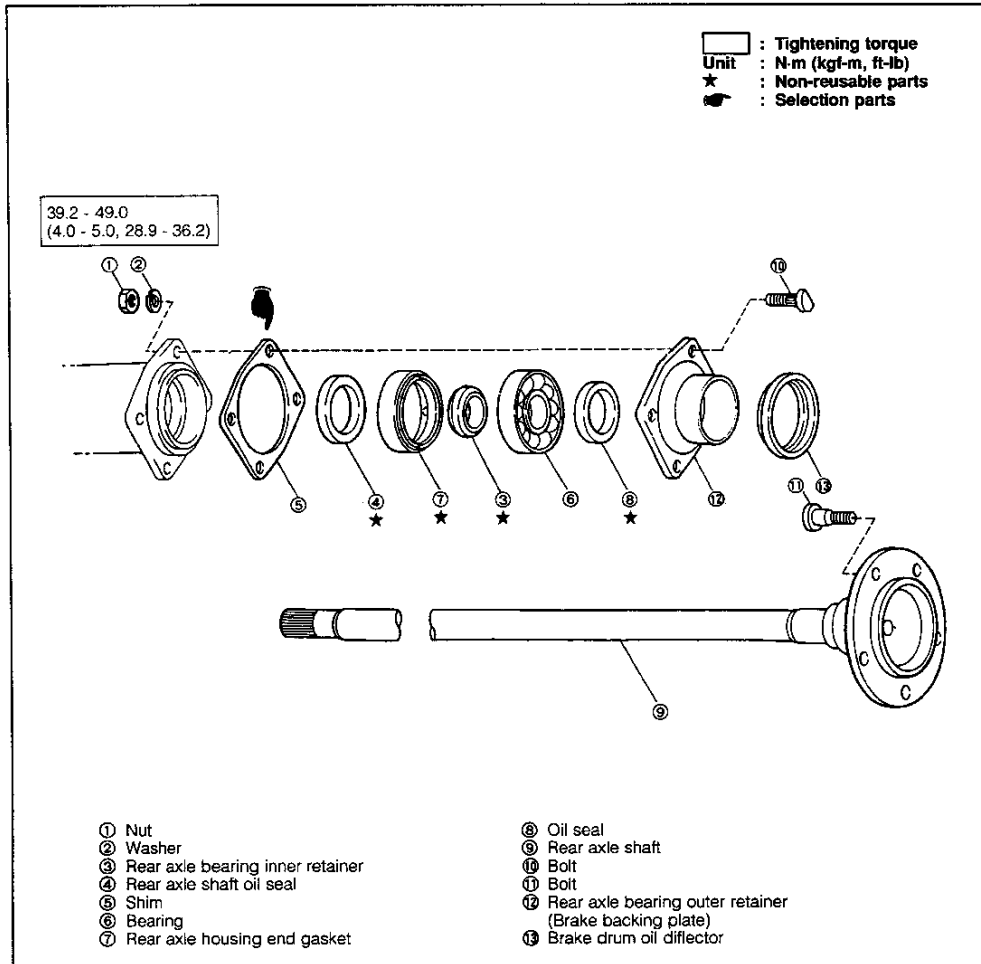

TROUBLE SHOOTING

Symptom	Possible causes	Checking points
Abnormal noise	Bearing damaged Bearing improperly lubricated	Check bearings.
Oil leakage	Oil seals damaged Oil seals improperly installed	Check oil seals.

WF890-RS103

REAR AXLE & SUSPENSION

REMOVAL

1. Disassemble the rear brake.
(For details see the Brake section.)

WFE90-RS104

2. Remove the attaching nuts of the backing plate from the rear axle housing.

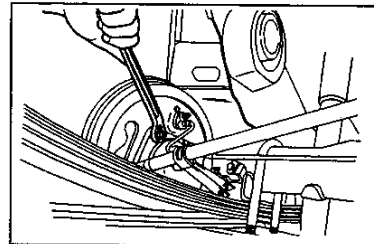

3. Remove the rear axle shaft, using the following SST.
SST: 09520-00031-000

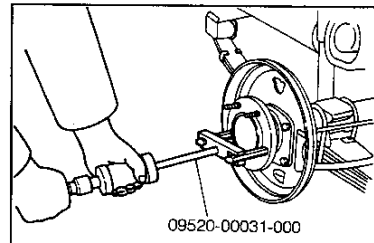

4. Remove the oil seal, using the following SST.
SST: 09520-00010-000

NOTE:

- Never reuse the oil seal.

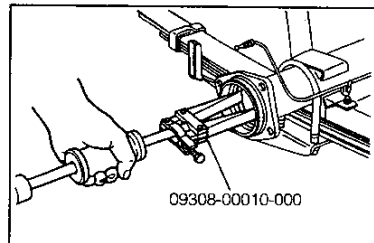

5. Remove the oil seal, using a screwdriver or the like.

NOTE:

- Never reuse the gasket.

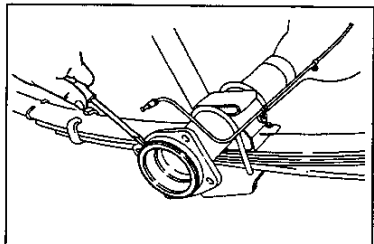

REAR AXLE & SUSPENSION

DISASSEMBLY

1. Grind off the retainer, using a hand grinder.

WARNING:

- Observe the operating instructions of the hand grinder. Also,, be sure to wear goggles during the grinding.

NOTE:

- Do not grind the rear axle shaft.

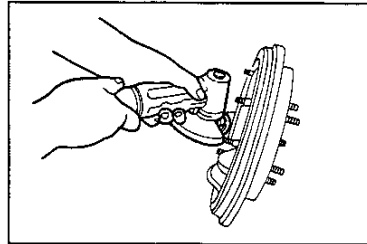

WFES0-RS109

2. Split the retainer with a chisel.

WARNING:

- Be sure to wear a pair of gloves and goggles during the operation.

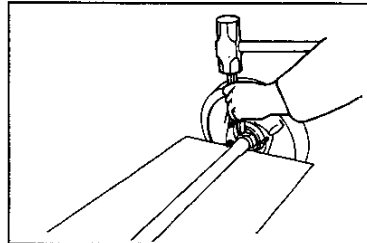

WFES0-RS110

3. Remove the retainer and bearing, using the following SSTs in combination with a socket wrench.

SST: 09520-87603-000
09956-00010-000

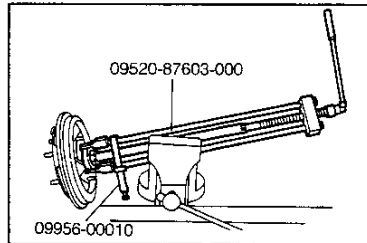

WFES0-RS111

4. Remove the backing plate from the rear axle shaft.

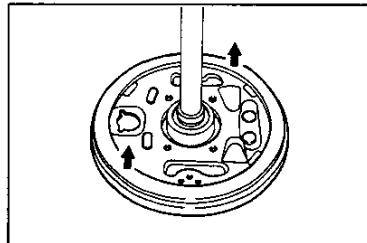

WFES0-RS112

5. Remove the shim from the backing plate.

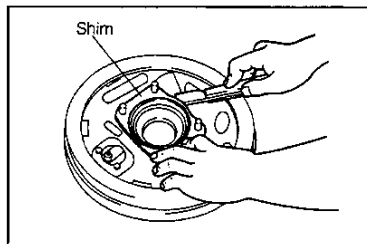

WFES0-RS113

REAR AXLE & SUSPENSION

6. Drive off the hub bolt from the rear axle shaft with a plastic hammer or the like.

NOTE:

- Be very careful not to damage the screw section.

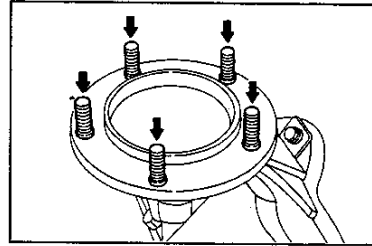

WFE90-RS114

7. Remove the oil seal from the backing plate using the following SST in combination with a hydrodic press.

SST: 09608-87604-000

NOTE:

- Be sure to use the flat surface of the SST.

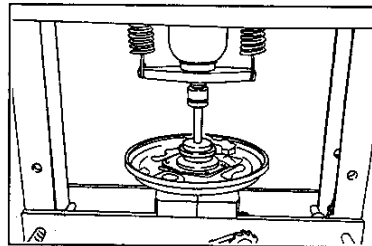

WFE90-RS115

INSPECTION

1. Rear axle shaft

- 1) Place the rear axle shaft on a "V" block. Ensure that the runout at the flange end surface is within the allowable limit.

Maximum Allowable Runout: 0.15 mm

NOTE:

- This maximum allowable runout does not include the runout caused by roughness on the flange surface.
- If the flange surface exhibits roughness, finish the surface with abrasive paper or the like.

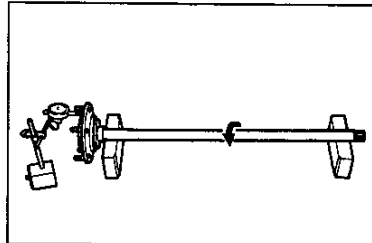

WFE90-RS116

- 2) Ensure that the rear axle shaft spline section exhibits no damage, such as cracks and wear. If any damage exists, replace the rear axle shaft.
- 3) Ensure that the oil seal contact surface of the rear axle shaft exhibits no damage, such as cracks, scores and/or rust. If any damage exists, replace the rear axle shaft.
- 4) Ensure that the oil deflector exhibits no damage, such as deformation. If any damage exists, replace the rear axle shaft.

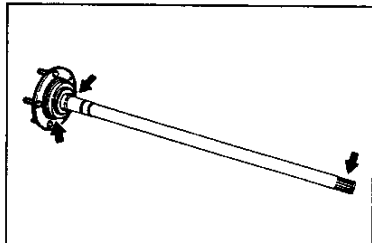

WFE90-RS117

2. Backing plate

Ensure that the backing plate exhibits no damage such as cracks, scores, rust and deformation. If any damage exists, replace the backing plate.

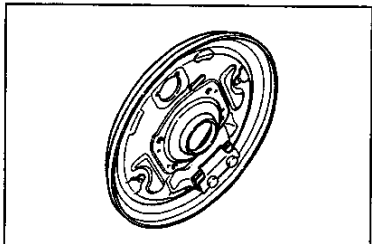

WFE90-RS118

REAR AXLE & SUSPENSION

ASSEMBLY

1. Pack the back side of the lip section of the oil seal with specified amount of lithium-based MP grease.
Specified Amount: 5 grams
Specified Grease: Lithium-based MP grease
2. Apply a thin film of lithium-based MP grease to the lip surface of the oil seal.

3. Drive the oil seal from the brake shoe attaching surface of the backing plate up to the wheel end surface of the backing plate, using the following SST.
SST: 09608-87606-000
09611-87506-000

NOTE:

- At this time, the oil seal should be installed in such a direction that the brake shoe attaching surface comes at the inner side.
 - Be very careful not to allow the oil seal to tilt.
 - Install the oil seal so that its surface may come at the brake shoe side.
4. Drive the serration bolt into the backing plate with the cut-out section of the serration bolt aligned with the backing plate.

5. Drive the hub bolt into the rear axle shaft with the cut-out section of the hub bolt aligned to the rear axle shaft.

6. Selection of shim
 - 1) Measure the dimension A of the backing plate at four points which are diagonally opposite with each other.

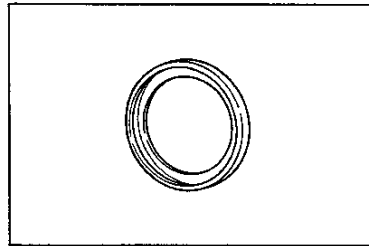

WFES0-RS119

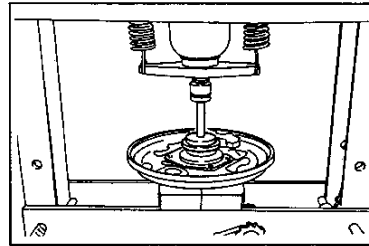

WFES0-RS120

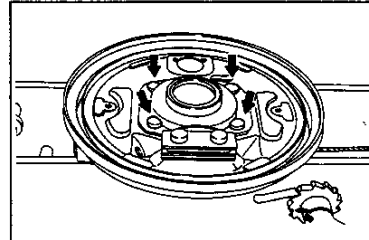

WFES0-RS121

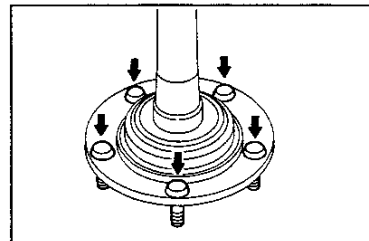

WFES0-RS122

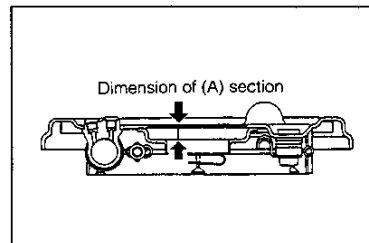

WFES0-RS123

REAR AXLE & SUSPENSION

- 2) Calculate the mean value of the measured four dimensions. Select a shim which corresponds to the calculated value, referring to the table below.

Dimension A of backing plate mm	Suitable thickness of adjusting shim mm
14.4 - 14.65	0.50
14.66 - 14.90	0.25

7. Install the backing plate to the rear axle shaft.

NOTE:

- Be very careful not to damage the oil seal during the installation.

8. Pack the back surface of the oil seal with 5 grams of lithium-based MP grease.

9. Pack the rear axle bearing with lithium-based MP grease.

NOTE:

- Grease should not be applied only to the surface. After packing the bearing with grease, apply grease also to the surface.

10. Install the rear axle bearing to the rear axle shaft.

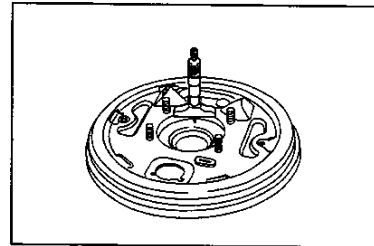

WFE90-RS124

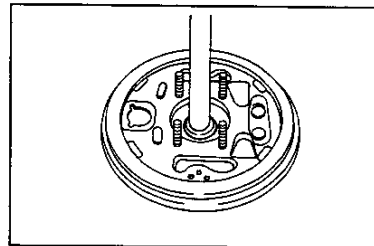

WFE90-RS125

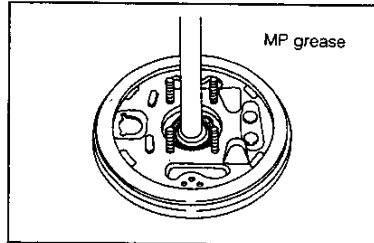

WFE90-RS126

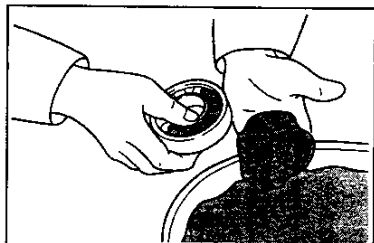

WFE90-RS127

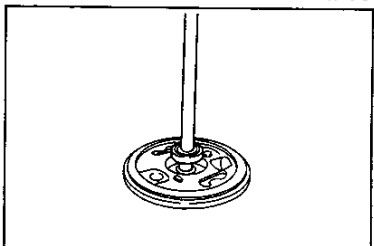

WFE90-RS128

REAR AXLE & SUSPENSION

11. Installation of rear axle bearing retainer

NOTE:

- Perform this operation promptly before the retainer temperature drops.

1) Heat the retainer to about $150 \pm 15^\circ\text{C}$

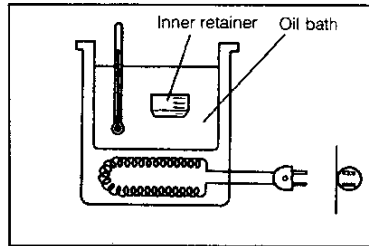

2) Install the retainer to the rear axle shaft.

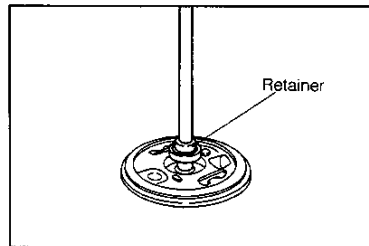

3) Press the retainer into the rear axle shaft, using a hydraulic press.

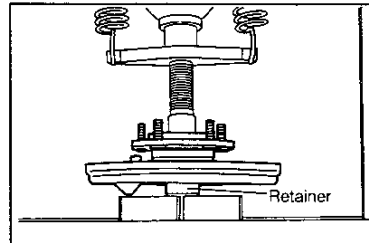

12. Apply 5 grams of lithium-based MP grease between the retainer and the bearing.

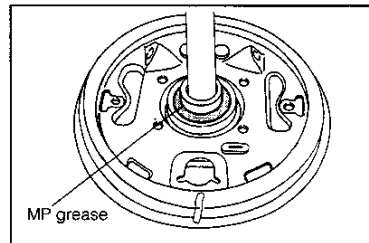

INSTALLATION

1. Apply lithium-based MP grease to the lip section of the oil seal.

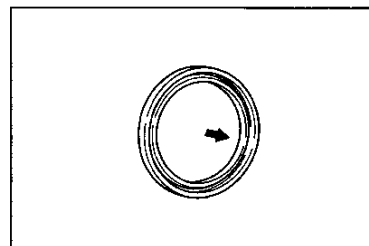

REAR AXLE & SUSPENSION

2. Press the oil seal into the rear axle housing, using the following SST.

SST: 09608-87607-000
09611-87506-000

NOTE:

- Care must be exercised not to allow the oil seal to be tilted.
- The oil seal should be installed in such a way that the surface comes at the wheel side.

3. Install the gasket to the rear axle housing.

4. Apply a thin film of Three Bond 1104[®] to the shim contact surface of the backing plate. Install the selected shim (at page RS-32) to the backing plate.

5. Apply a thin film of Three Bond 1104[®] to the backing plate installing surface of the axle housing.

6. Insert the rear axle shaft into the rear axle housing. Install the backing plate to the rear axle in such a way that the attaching bolt of the backing plate is aligned with the attaching hole of the rear axle housing and that the wheel cylinder installing hole of the backing plate comes at the upper side.

NOTE:

- 1) Turn the axle shaft so that the spline at the differential side may engage with the spline at the axle shaft side.
- 2) Be very careful not to damage the oil seals.

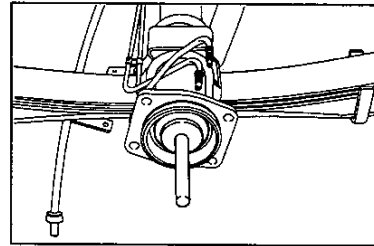

WFE90-RS134

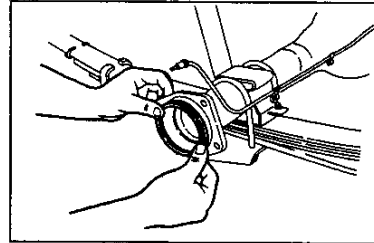

WFE90-RS135

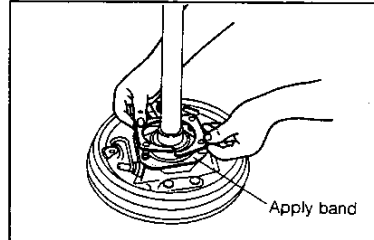

WFE90-RS136

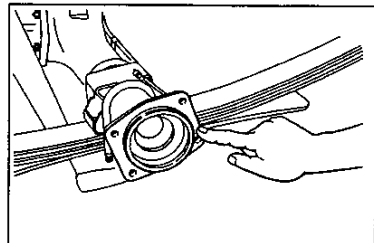

WFE90-RS137

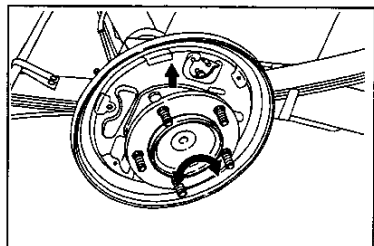

WFE90-RS138

REAR AXLE & SUSPENSION

7. Attach the backing plate attaching nuts and tighten them to the specified torque evenly over two or three stages.

Tightening Torque: 39.2 - 49 N·m
(4.0 - 5.0 kgf-m, 28.9 - 36.2 ft-lb)

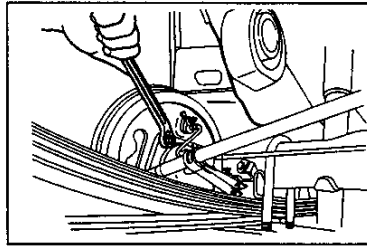









WFEG0-RS139

8. Assemble the rear brake.
(For details, see the Brake section.)

WFEG0-RS140

REAR AXLE & SUSPENSION

SSTs (special service tools)

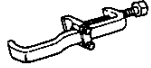
Shape	Parts No. and Name	Purpose	Remarks
	09308-00010-000 Oil seal puller	Removal of rear axle shaft oil seal	
	09520-00031-000 Rear axle shaft puller	Removal of rear axle shaft	
	09520-87603-000 Rear wheel bearing puller set	Removal of rear axle bearing	
	09608-87604-000 Front axle hub inner bearing outer race replacer	Removal of rear axle shaft oil seal	
	09608-87606-000 Rear axle shaft oil seal replacer	Installation of rear axle shaft oil seal	
	09608-87607-000 Leaf spring bush No.1 remover & replacer	Removal/installation of leaf spring bush No.1	
	09608-87608-000 Leaf spring bush No.2 remover & replacer	Removal/installation of leaf spring bush No.2	
	09611-87506-000 Handle	Used as a handle for rear axle shaft oil seal replacer	
	09956-00010-000 Tightening piece	Used in combination with rear wheel bearing puller set	

WF690-RS141

REAR AXLE & SUSPENSION

TIGHTENING TORQUE

Tightening component	N·m	kgf·m	ft·lb
Rear spring shackle	68.6 - 88.3	7.0 - 9.0	50.6 - 65.1
Leaf spring x Frame	118 - 137	12 - 14	87 - 101
"U"bolt	58.8 - 78.5	6.0 - 8.0	43.4 - 57.9
Rear shock absorber x Frame	18.6 - 30.4	1.9 - 3.1	13.7 - 22.4
Rear shock absorber x "U" bolt seat	34.3 - 53.9	3.5 - 5.5	25.3 - 39.8
Rear shock absorber x shock absorber control bracket (Three stage damper only)	25.5 - 38.2	2.6 - 3.9	18.8 - 28.2
Rear axle housing x Backing plate	39.2 - 49.0	4.0 - 5.0	28.9 - 36.2
Rear spring bumper x Frame	14.7 - 21.6	1.5 - 2.2	10.8 - 15.9
Rear shock absorber x Frame (Lock nut)	18.6 - 30.4	1.9 - 3.1	13.7 - 22.4
Shock absorber x Actuator (Three stage damper only)	2.0 - 3.9	0.2 - 0.4	1.4 - 2.9

WFE90-RS142